

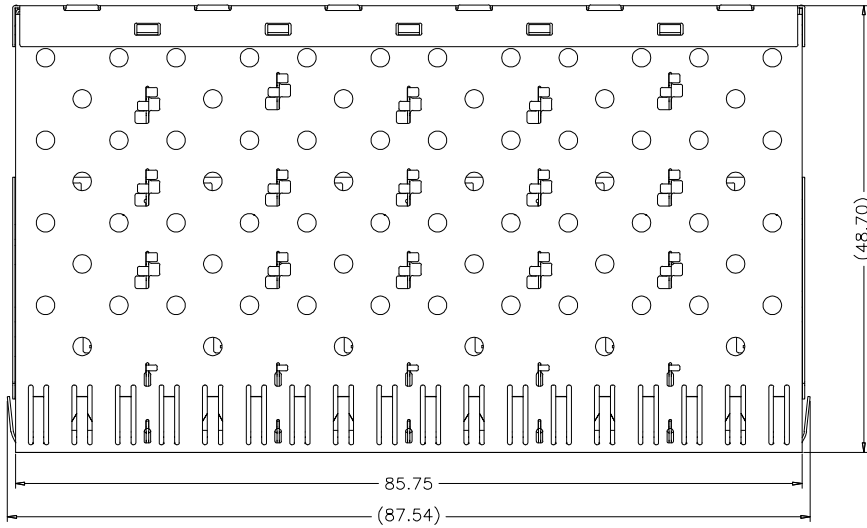

REV:	ECN. NO.	NAME	DATE



NOTES:

- 1.MATERIAL: NICKEL SILVER, THICKNESS 0.25mm
- 2.PACKAGING: TRAY PACKAGING
- 3.TEMPERATURE:
OPERATION : -40°C TO +85°C
STORAGE : -55°C TO +105°C

P/N: S1N3600100A4
 MATERIAL CODE:
 N3: NICKEL SILVER
 01: METAL ALLOY

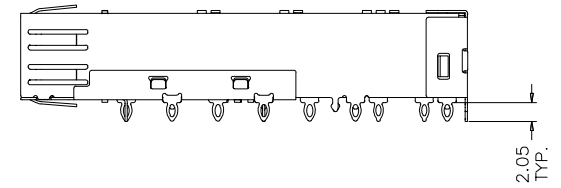
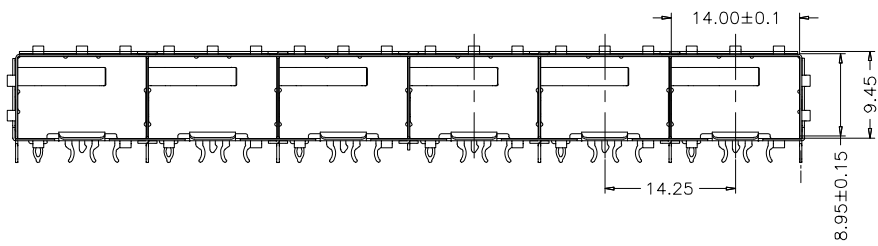

TOLERANCE UNSPECIFIED		 a vital connector company		FOR YOUR VITAL CONNECTION	
.0	±0.38			TITLE: SFP 1*6 CAGE	
.00	±0.25	DRAWN BY: QSY		PART NO: S1N3600100NA4	
.000	±0.10	CHECKED BY: VIT		REV: A	
ANGLE	±2.00°	APPROVED BY: QPF		SIZE: A4	
MANUFACTURING COPY		PROJECTION		UNIT:mm	SHEET: 1 OF 4
				FCN: A4	http://www.vitalconn.com

For technical support, please send an email to support@vitalconn.com



REV:	ECN. NO.	NAME	DATE

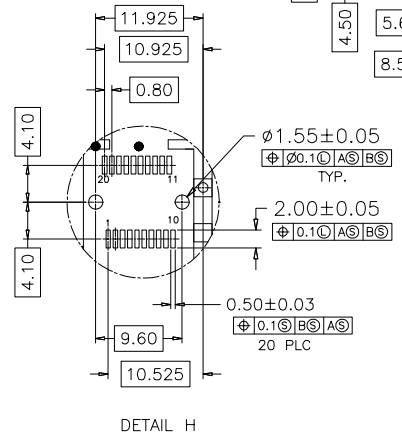
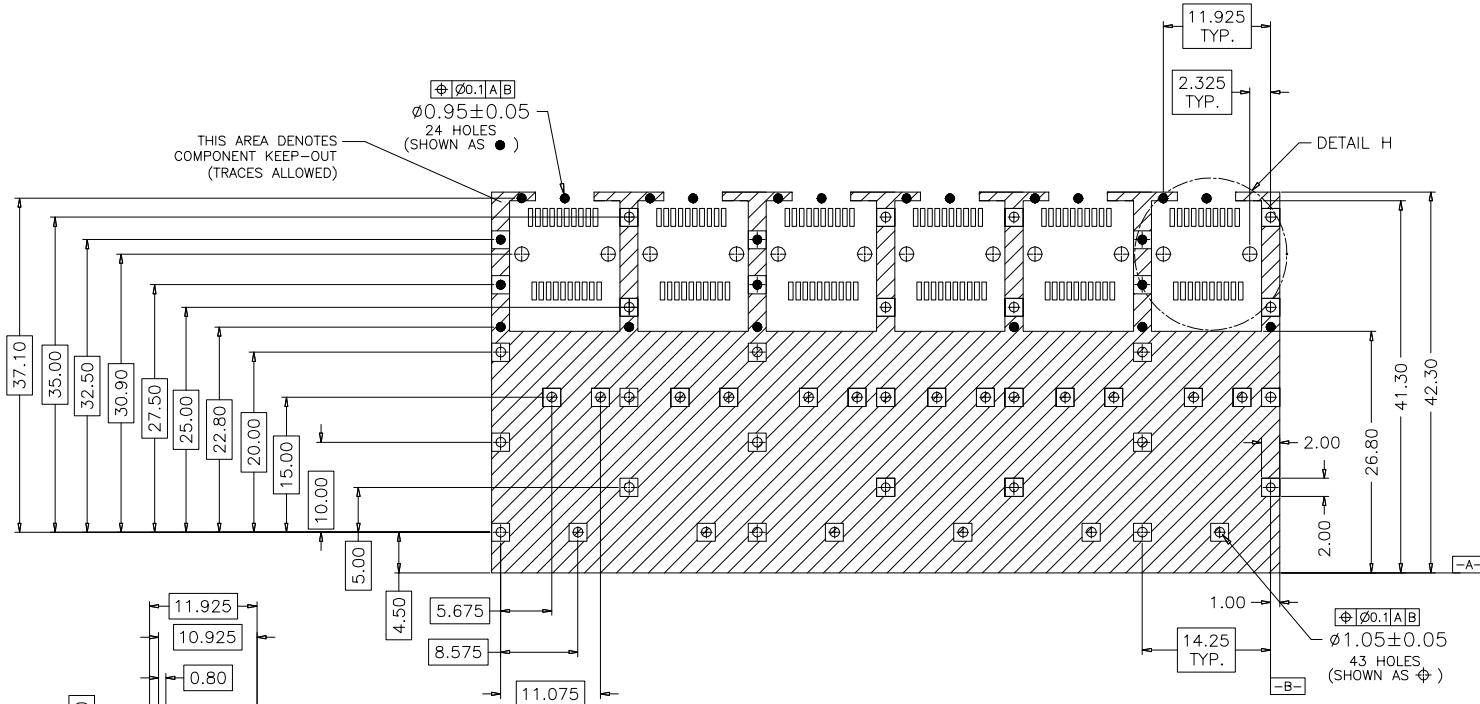

PCB LAYOUT FOR SINGLE SIDE MOUNTING

For technical support, please send an email to support@vitalconn.com

TOLERANCE UNSPECIFIED				FOR YOUR VITAL CONNECTION	
.0	±0.38				
.00	±0.25	TITLE:		SFP 1*6 CAGE	
.000	±0.10	DRAWN BY: QSY		PART NO: S1N3600100NA4	
ANGLE ±2.00°	MANUFACTURING COPY	CHECKED BY: VIT		REV: A	
APPROVED BY: QPF		SIZE: A4		UNIT:mm	SHEET: 2 OF 4
PROJECTION				FCN: A4	
		http://www.vitalconn.com			



REV:	ECN. NO.	NAME	DATE

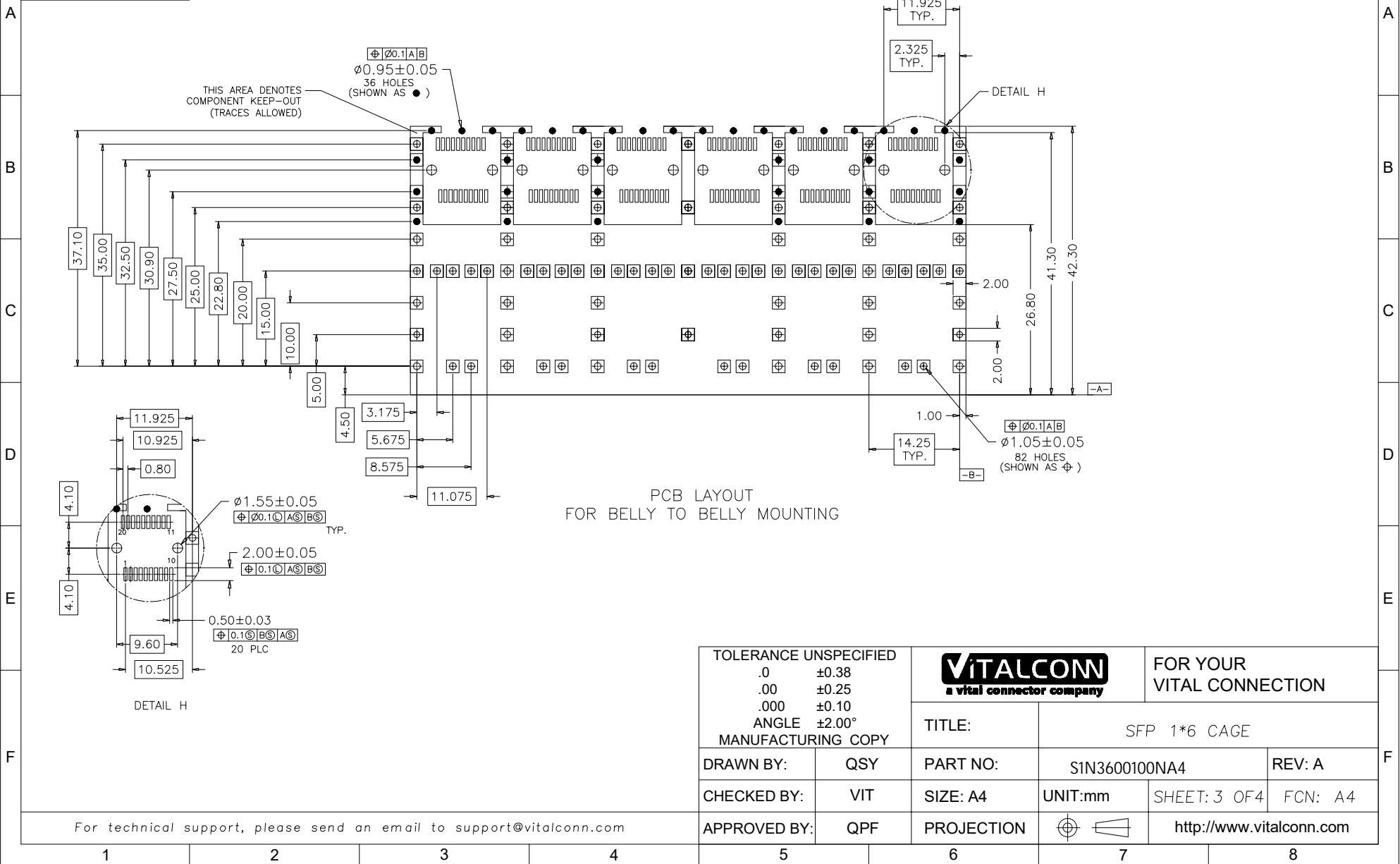

TOLERANCE UNSPECIFIED

.0	±0.38
.00	±0.25
.000	±0.10
ANGLE	±2.00°

MANUFACTURING COPY



FOR YOUR VITAL CONNECTION

TITLE:		SFP 1*6 CAGE	
DRAWN BY:	QSY	PART NO:	S1N3600100NA4
CHECKED BY:	VIT	SIZE: A4	UNIT:mm
APPROVED BY:	QPF	PROJECTION	http://www.vitalconn.com

For technical support, please send an email to support@vitalconn.com



7	8
REV:	ECN. NO.
NAME	DATE

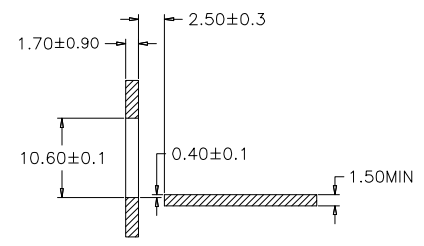
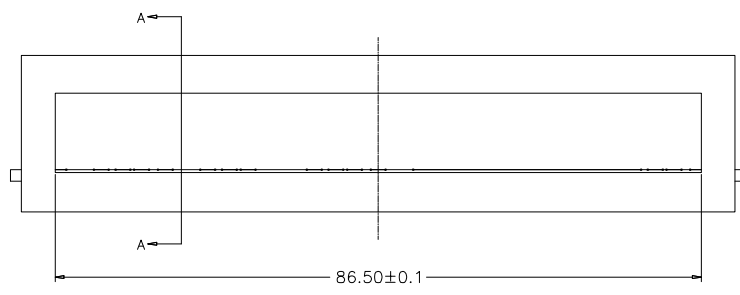

SECTION A-A

MOUNTED ON PC BOARD
SHOWN THRU RECOMMENDED BEZEL

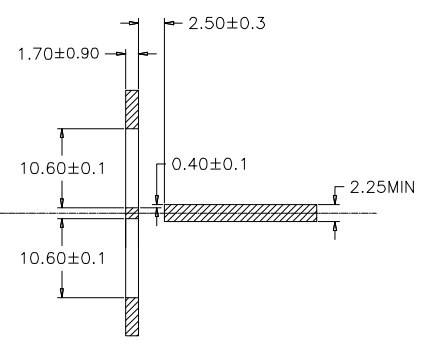
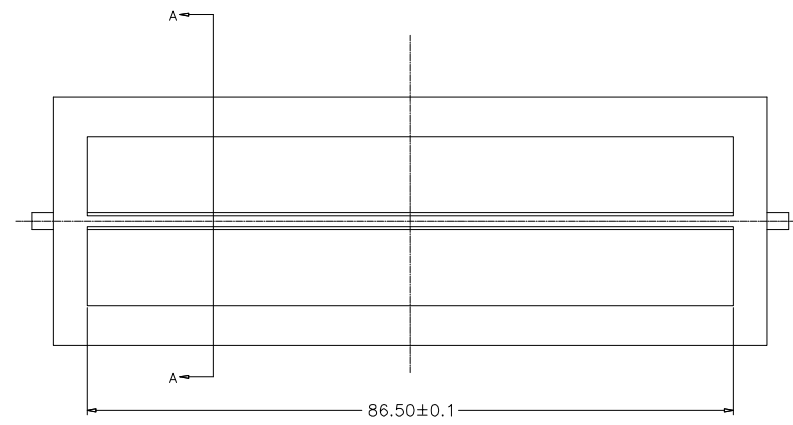

SECTION A-A

MOUNTED BELLY TO BELLY ON PC BOARD
SHOWN THRU RECOMMENDED BEZEL

TOLERANCE UNSPECIFIED	
.0	±0.38
.00	±0.25
.000	±0.10
ANGLE	±2.00°
MANUFACTURING COPY	



FOR YOUR
VITAL CONNECTION

TITLE:	SFP 1*6 CAGE		
--------	--------------	--	--

DRAWN BY:	QSY	PART NO:	S1N3600100NA4	REV: A
-----------	-----	----------	---------------	--------

CHECKED BY:	VIT	SIZE: A4	UNIT:mm	SHEET: 4 OF 4	FCN: A4
-------------	-----	----------	---------	---------------	---------

APPROVED BY:	QPF	PROJECTION		http://www.vitalconn.com
--------------	-----	------------	--	-----------------------------------------------------------------

For technical support, please send an email to support@vitalconn.com