

7		8	
REV:	ECN. NO.	NAME	DATE

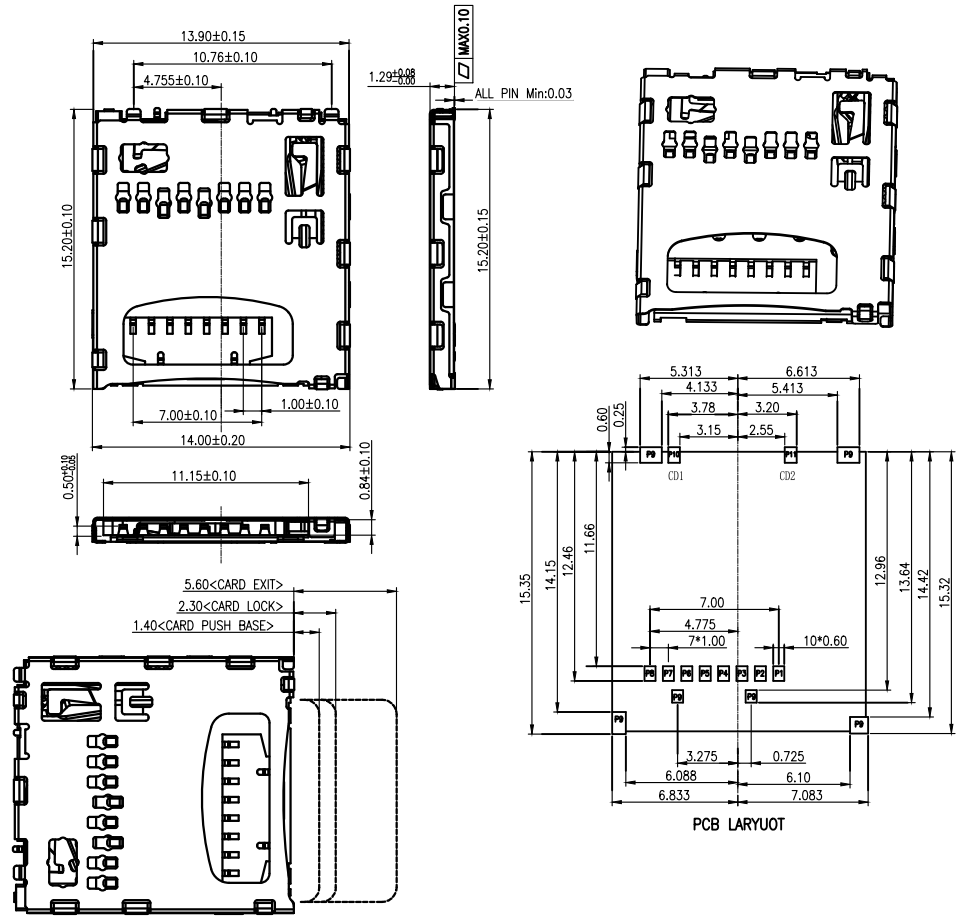

PIN ASSIGNMENTS

Pin#	Name	Description
1	DAT2	Data Line(Bit 2)
2	CD/DAT3	Card Detect/Data line(Bit 3)
3	CMD	Command/Response
4	V _{DD}	Supply voltage
5	CLK	Clock
6	V _{SS}	Supply voltage ground
7	DAT0	Data Line (Bit 0)
8	DAT1	Data Line (Bit 1)
9	GND	
10	COMMON	CD1
11	DETECT SW(GND)	CD2

- NOTES:
- Material
Housing:LCP UL94V-0 Black
Terminal:Phosphor Bronze T=0.12
Cover:SUS304 T=0.10
 - Plating:
Terminal:
Contact Area:Gold Flsh
Solder Area:Gold Flsh
Cover:
Solder Area:Gold Flsh
Underplating:Ni overall 50µ" min
 - Technical Speciality:
Rated Voltage: 50V
Current Rating: 0.5A
Insulation Resistance:1000MΩ Min.
Contact Resistance:100mΩ Max.
Withstanding Voltage: 500V DC For 1 Minutes.
 - Mechanical&Environmental
Operating Temperature:-45°C to +75°C
Durability:5000 cycles

RoHS Compliant

CARD INSERT LARYUOT

PCB LARYUOT

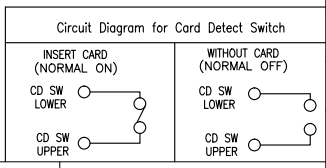

MILLIMETERS X.° ± 2° .X ± 0.30 .XX ± 0.20 .XXX ± 0.10	INCH X.° ± 2° .X ± 0.012 .XX ± 0.008 .XXX ± 0.004		FOR YOUR VITAL CONNECTION	
DRAWN BY: Zou Long			TITLE: MICRO SD H1.29 PUSH PUSH	
CHECKED BY: Bob		PART NO: VTC102593482	REV: A	
APPROVED BY: QPF		SIZE: A4	UNIT:mm	
		PROJECTION	SHEET:1 OF 2	
			FCN: E1	
			http://www.vitalconn.com	

A
B
C
D
E
F

A
B
C
D
E
F

7		8	
REV:	ECN. NO.	NAME	DATE

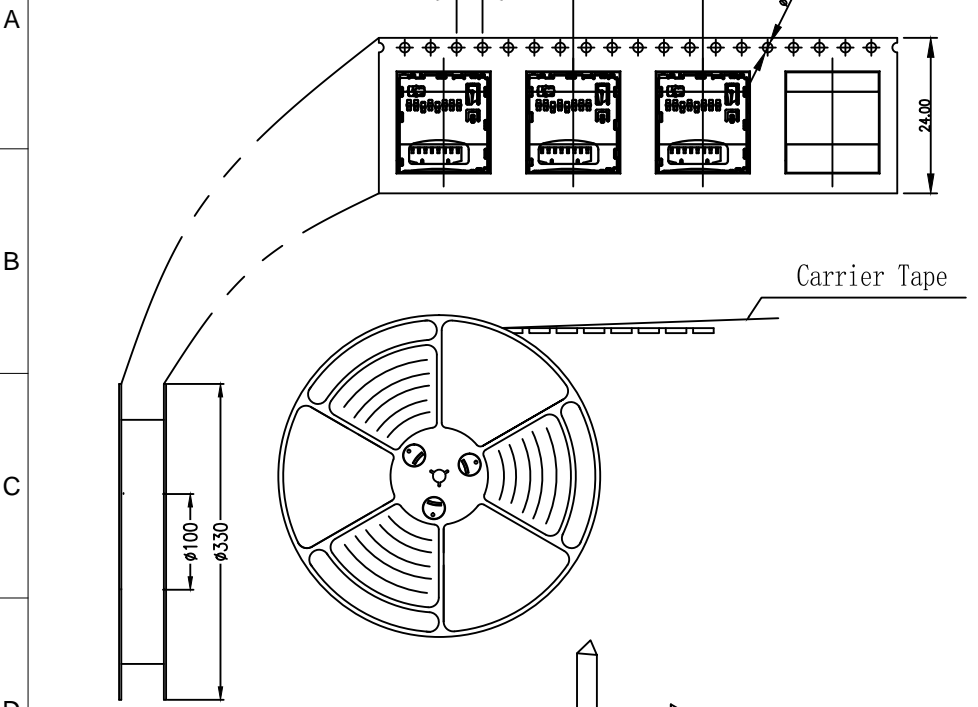

- NOTES:
- 1、Packing quantity per plate: 1000PCS/Plate
 - 2、Loading and packing method

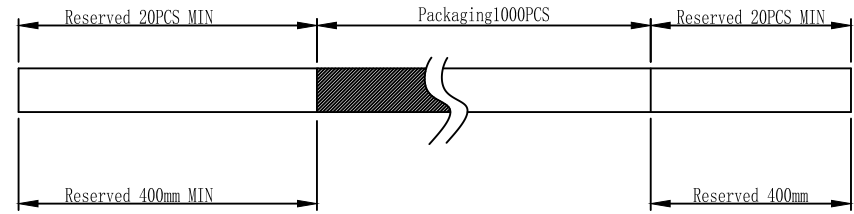

3、Total packaging: 10000PCS/Box

The bottom and top of the carton Pad it with apiece of pearl cotton

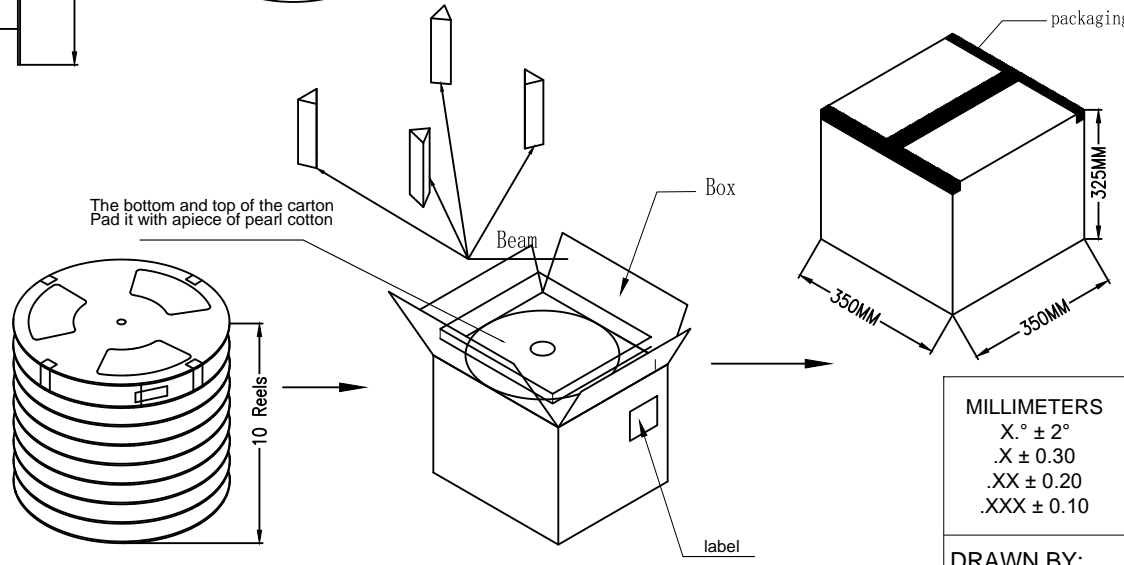

RoHS Compliant

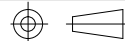
MILLIMETERS X. ^o ± 2° .X ± 0.30 .XX ± 0.20 .XXX ± 0.10		INCH X. ^o ± 2° .X ± 0.012 .XX ± 0.008 .XXX ± 0.004		 a vital connector company		FOR YOUR VITAL CONNECTION	
DRAWN BY: Zou Long		TITLE: MICRO SD H1.29 PUSH PUSH		PART NO: VTC102593482		REV: A	
CHECKED BY: Bob		SIZE: A4		UNIT:mm		SHEET:2 OF 2 FCN: E1	
APPROVED BY: QPF		PROJECTION				http://www.vitalconn.com	