

REV:	ECN. NO.	NAME	DATE

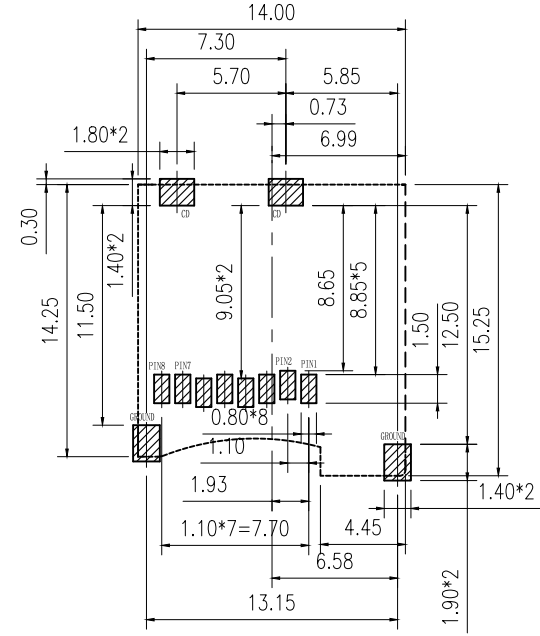
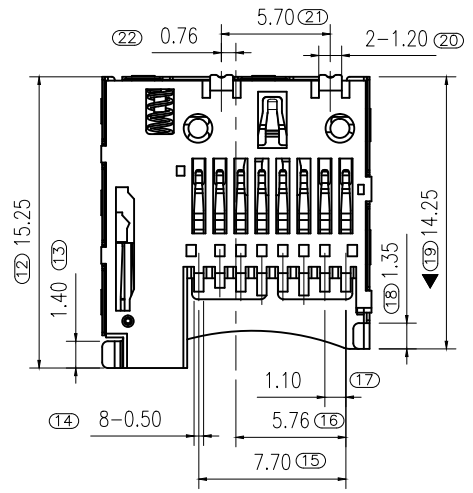
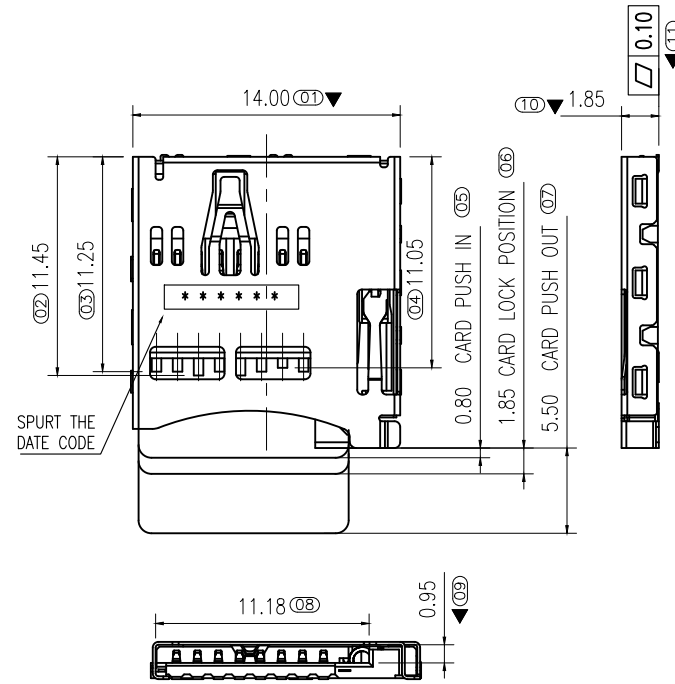

RECOMMEND PCB LAYOUT  
GENERAL TOLERANCE ±0.05

Specification

**Material**  
Plastic Housing: LCP 30%GF, UL94V-0, Black  
Contact Terminal: Phosphor Bronze, T=0.12mm  
Cover: SUS304, T=0.15mm

**Plating:**  
Contact Terminal  
Contact Area: Gold Flash  
Solder area: Tin 80u" min.  
Underplating: Ni overall 50u" min.  
Cover: Ni overall 30u" min.  
Solder area: Gold Flash

**Electrical**  
Voltage Rating: 30V max.  
Current Rating: 0.5A max.  
Dielectric Withstanding Voltage: 100V AC (60 Sec min.)  
Insulation Resistance: 1000 MΩ min.  
Contact Resistance: 100 mΩ max.

**Mechanical & Environmental**  
Operating Temperature: -40°C to +85°C  
Durability: 5000 cycles

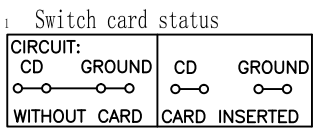
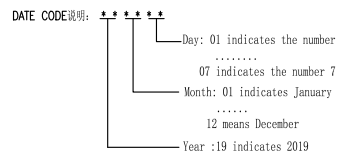

Pin No.	MICRO SD
PIN1	DAT2 1P
PIN2	CD/DAT3 2P
PIN3	CMD 3P
PIN4	VDD 4P
PIN5	CLK 5P
PIN6	VSS 6P
PIN7	DAT0 7P
PIN8	DAT1 8P
PIN9	CARD DETECT
PIN10	

MILLIMETERS	INCH
X.° ± 2°	X.° ± 2°
.X ± 0.30	.X ± 0.012
.XX ± 0.20	.XX ± 0.008
.XXX ± 0.10	.XXX ± 0.004

DRAWN BY:	Zou Long
CHECKED BY:	Bob
APPROVED BY:	QPF

		FOR YOUR VITAL CONNECTION	
		TITLE: 1.85H P_P TF Card常闭一体式 内焊	
PART NO:	VTC102014462	REV:	A
SIZE: A4	UNIT:mm	SHEET: 1 OF 2	FCN: E1
PROJECTION		http://www.vitalconn.com	

# RoHS Compliant

7		8	
REV:	ECN. NO.	NAME	DATE

NOTES

1. 每卷包装数量:1000PCS/每卷
2. 卷带包装方式:

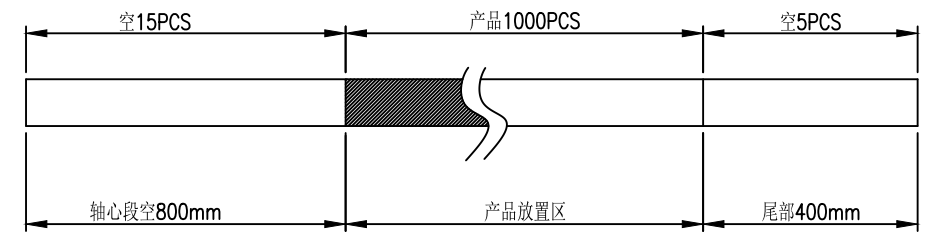

3. 每箱包装数量:10000PCS/箱

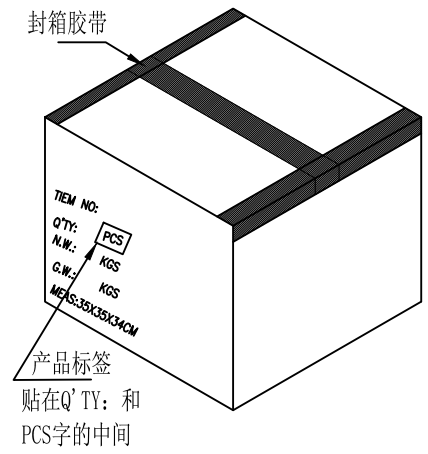

RoHS Compliant

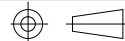
MILLIMETERS X.° ± 2° .X ± 0.30 .XX ± 0.20 .XXX ± 0.10	INCH X.° ± 2° .X ± 0.012 .XX ± 0.008 .XXX ± 0.004	 <b>VITALCONN</b> <small>a vital connector company</small>		FOR YOUR VITAL CONNECTION	
DRAWN BY: Zou Long		TITLE: 1.85H P_P TF Card常闭一体式 内焊		REV: A	
CHECKED BY: Bob		PART NO: VTC102014462		SHEET: 2 OF 2 FCN: E1	
APPROVED BY: QPF		SIZE: A4		UNIT: mm	
PROJECTION				<a href="http://www.vitalconn.com">http://www.vitalconn.com</a>	

