

REV.	ECN. NO.	NAME	DATE

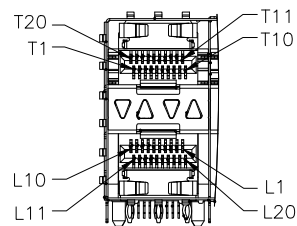

DETAIL A
1:1

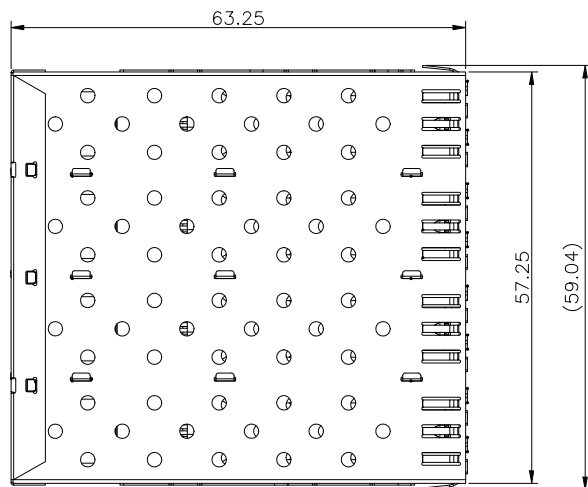
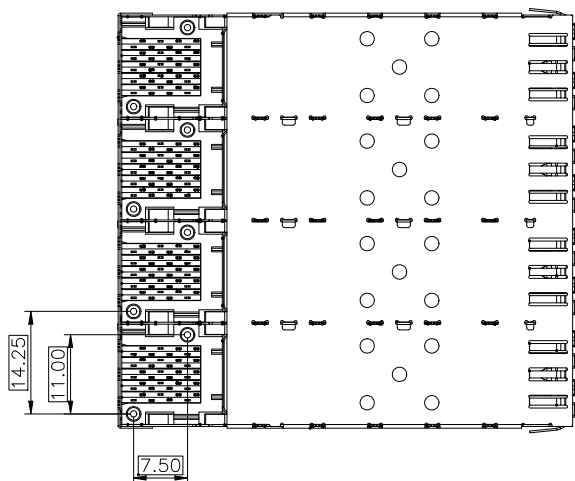
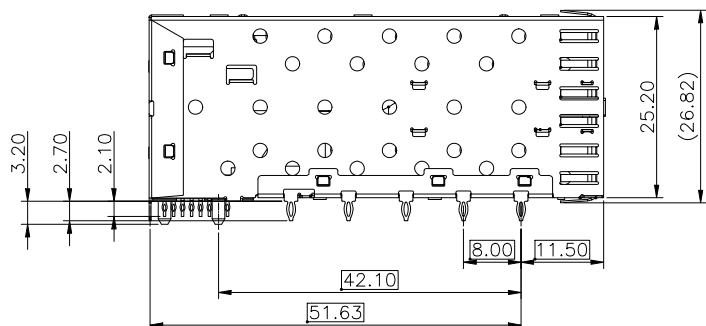
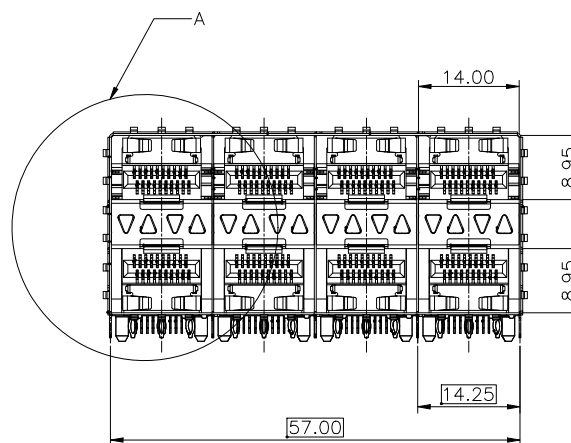

NOTES:

MATERIAL:
 CAGE: NICKEL SILVER, THICKNESS 0.25mm
 LIGHT PIPE: POLYCARBONATE, COLOR: CLEAR.
 CONNECTOR:
 PLASTIC HOUSING: HIGH TEMPERATURE LCP, UL94 V-0.
 SPRING: STAINLESS STEEL, THICKNESS 0.20mm
 CONTACTS: PHOSPHOR BRONZE, THICKNESS 0.20mm
 PLATING: 15μ" MIN. GOLD ON MATING AREA,
 150μ" MIN. MATE TIN ON SOLDER TAILS.

PACKAGING: TRAY PACKAGING.

TEMPERATURE RANGE: -40°C TO +85°C

RoHS Compliant

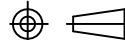
TOLERANCE UNSPECIFIED		 a vital connector company		FOR YOUR VITAL CONNECTION	
.0	± 0.38			TITLE: SFP2*4 CAGE+CONN	
.00	± 0.25	DRAWN BY: BECKER	PART NO: SC242	REV: A	
.000	± 0.10	CHECKED BY: VTA	SIZE: A4	UNIT:mm	SHEET:10F3
ANGLE	± 3.00°	APPROVED BY: QPF	PROJECTION		http://www.vitalconn.com
MANUFACTURING COPY					

REV.	ECN. NO.	NAME	DATE

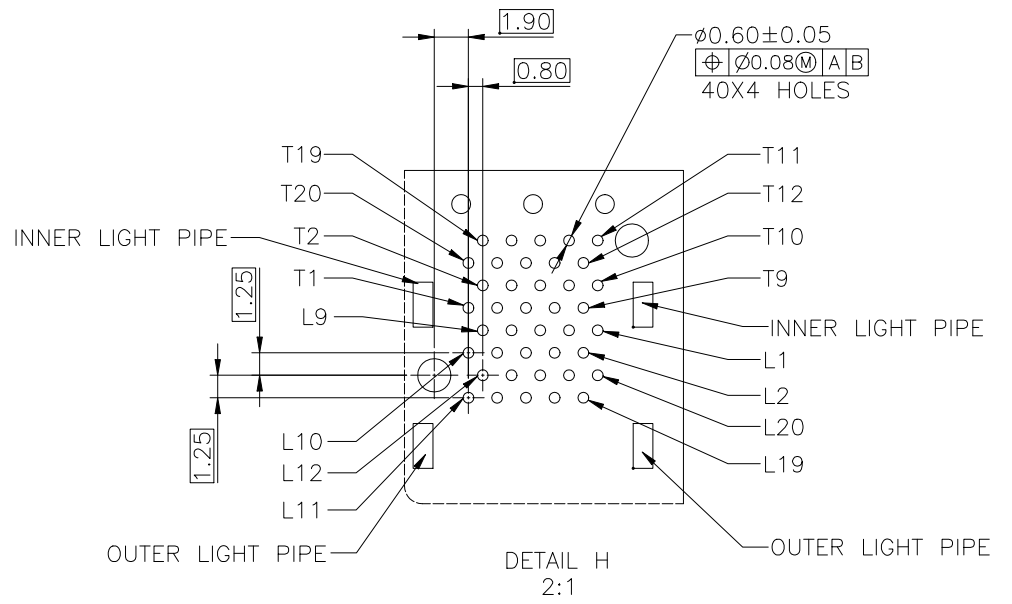
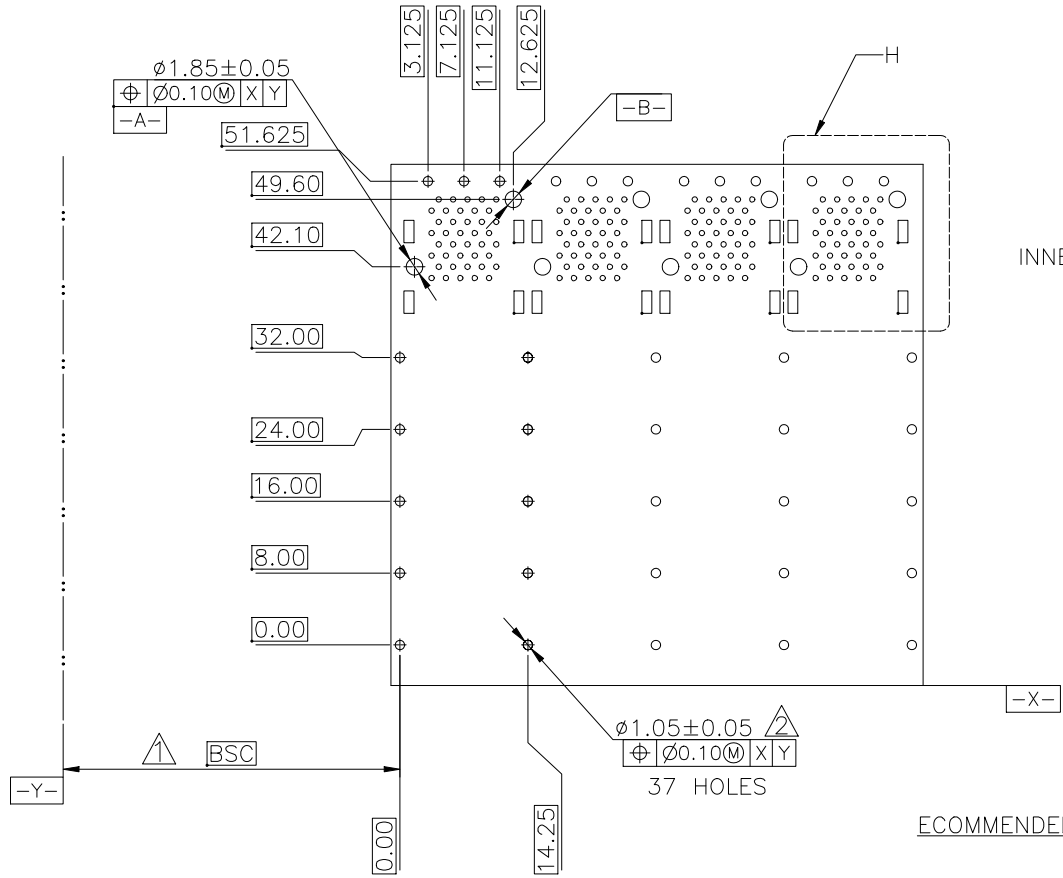

ECOMMENDED PCB CONFIGURATION

RoHS Compliant

NOTES:

1. DATUM AND BASIC DIMENSIONS ESTABLISHED BY CUSTOMER.
2. 1.05 mm DIAMETER HOLES ARE CHASSIS GROUND.

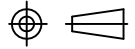
TOLERANCE UNSPECIFIED		 a vital connector company		FOR YOUR VITAL CONNECTION	
.0	± 0.38			TITLE: SFP2*4 CAGE+CONN	
.00	± 0.25	DRAWN BY: BECKER	PART NO: SC242	REV: A	
.000	± 0.10	CHECKED BY: VTA	SIZE: A4	UNIT: mm	SHEET: 20F3
ANGLE	± 3.00°	APPROVED BY: QPF	PROJECTION		http://www.vitalconn.com
MANUFACTURING COPY					

REV.	ECN. NO.	NAME	DATE

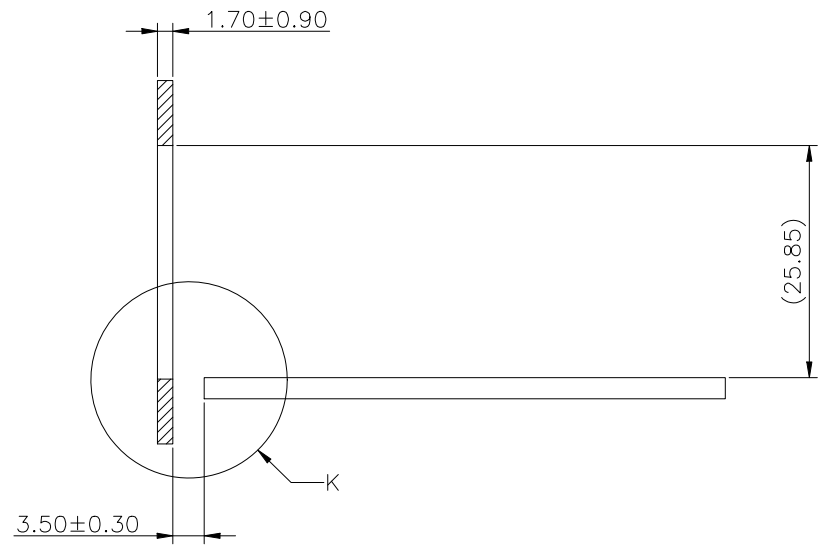
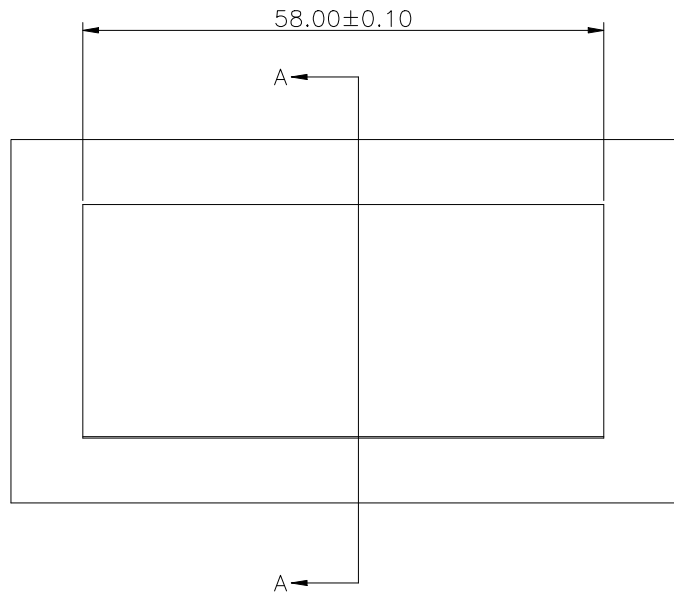

SECTION A-A

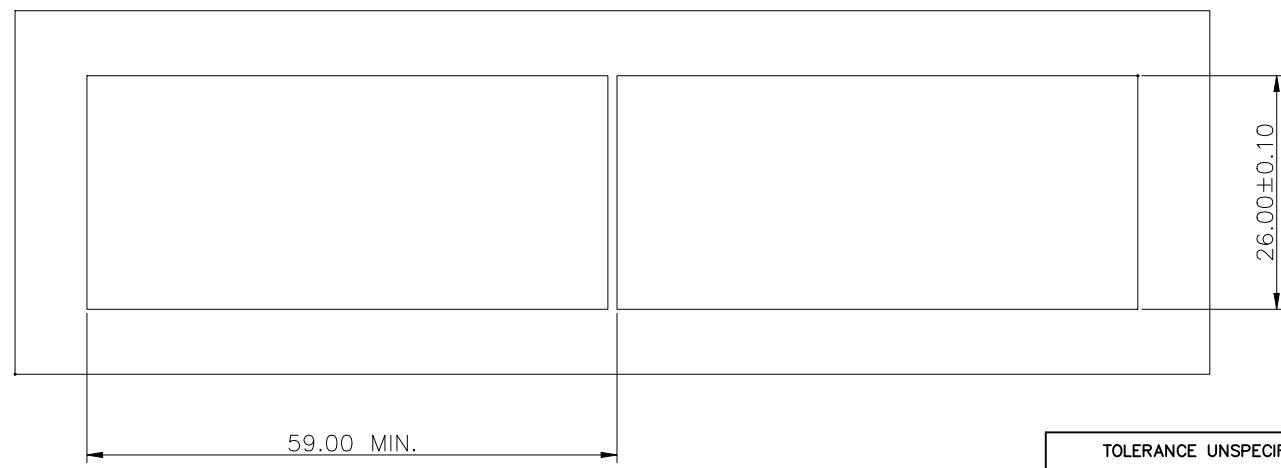

RECOMMENDED BEZEL DESIGN

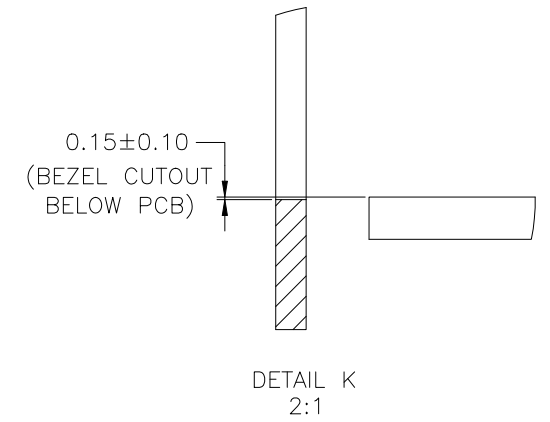

DETAIL K
2:1

RoHS Compliant

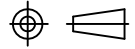
TOLERANCE UNSPECIFIED				FOR YOUR VITAL CONNECTION	
.0	± 0.38			TITLE: SFP2*4 CAGE+CONN	
.00	± 0.25	DRAWN BY: BECKER	PART NO: SC242	REV: A	
.000	± 0.10	CHECKED BY: VTA	SIZE: A4	UNIT:mm	SHEET:30F3
ANGLE	± 3.00°	APPROVED BY: QPF	PROJECTION		FCN: A4
MANUFACTURING COPY				http://www.vitalconn.com	