

1000 BASE-T QUAD PORT Magnetic Modules with PoE Plus Option

MODEL NO.: TG88010D1

FEATURE:

RoHS Compliant
Compliant With IEEE802.3at Requirement
Operating Temperature : -40°C ~ + 85°C
Storage Temperature Range: -25°C to +85°C.

SPECIFICATIONS: @ 25°C

OCL : 350 uH Min @100kHz ,100mV with 8mA DC BIAS

OCL : 200uH Min. @100kHz ,100mV with 18mA DC BIAS

Insertion Loss (MHz) (dB MAX)	Return Loss (MHz) (dB MIN)					Cross talk (MHz) (dB MIN)			DCMR (DB min)			Hi-Pot (Vrms MIN)
	1~30	40	50	60~80	100	30	60	100	30	60	100	
-1.0	-18	-16	-14	-12	-10	-43	-37	-33	-43	-37	-33	1500

SCHEMATICS :

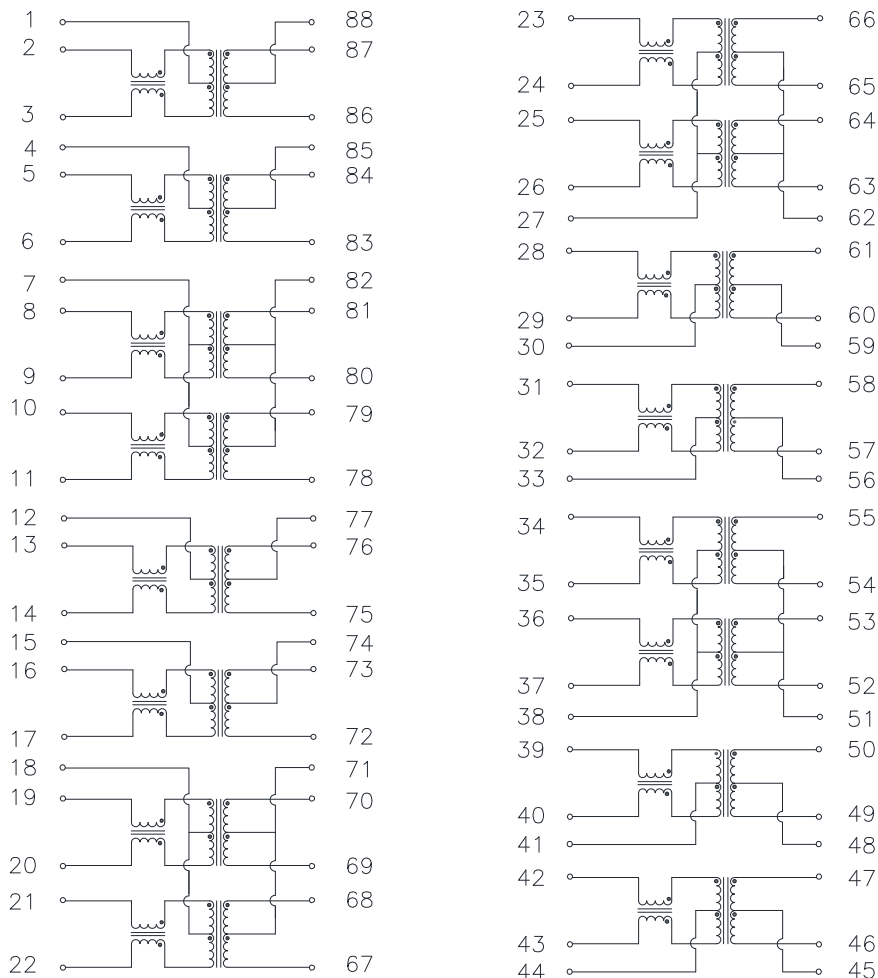

MODEL NO.: TG88010D1

DIMENSION : Unit :mm Tolerance : xx.xx ± 0.25 0.xx ± 0.05

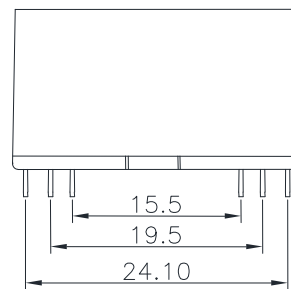
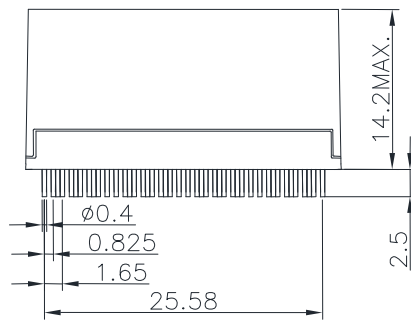
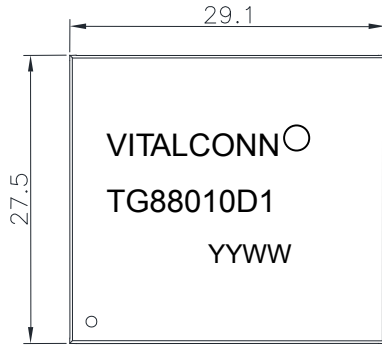

PCB Layout mounting Hole (Top View)

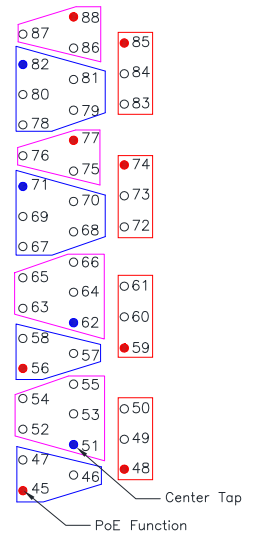
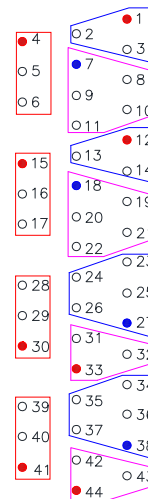
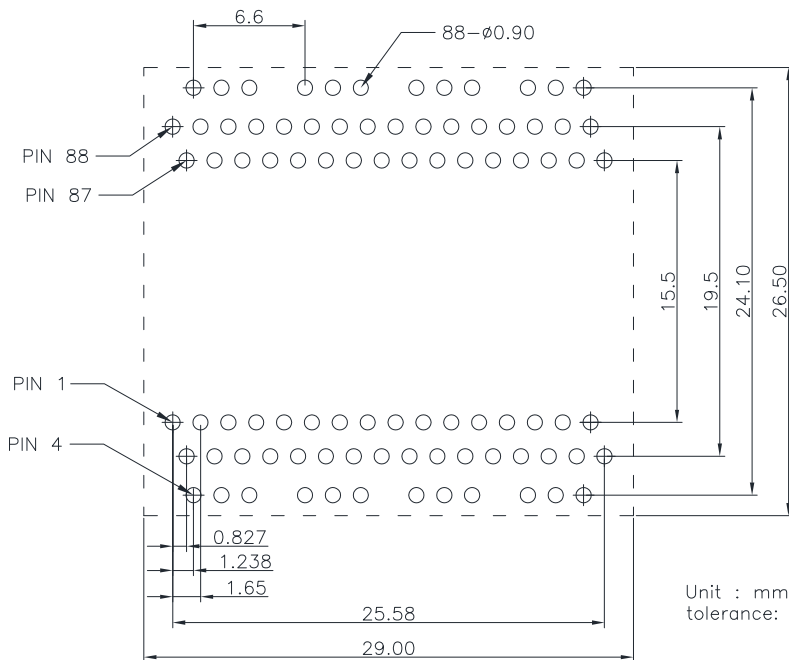

Unit : mm
tolerance: xx.xx±0.25
0.xx±0.05